



Cedar Pattern Siding

CHANNEL GRADED TO THE RESAWN FACE

CCHK106	1 x 6	STK
CCHK108K	1 x 8	STK
CCHK110K	1 x 10	STK



CHANNEL | COVE GRADED TO THE RESAWN FACE

CCHK106P	1 x 6	STK
CCHK108P	1 x 8	STK



LOG CABIN | KD | WESTERN INCENSE

C LC208	2 x 8	STK
---------	-------	-----

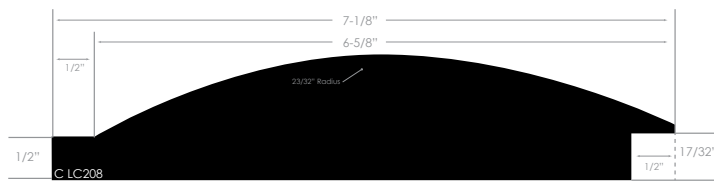



Cedar T&G Siding

T&G V2E | A/BTR

6' and longer

CTA104V2	1 x 4	CLR
CTA106V2	1 x 6	CLR

T&G V2E TK

CT104V2	1 x 4	STK
CT106V2	1 x 6	STK

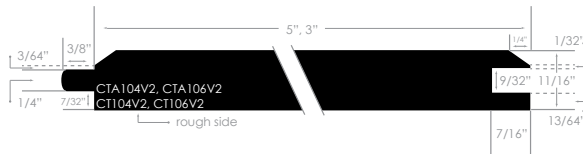

T&G V4E TK

CTL106V4	1 x 6	STK
CT108V4	1 x 8	STK

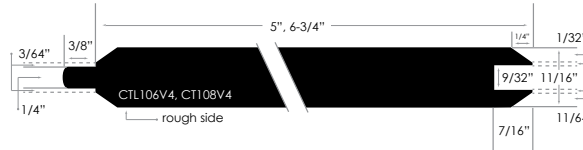

T&G V2E | A/BTR

FINGER-JOINTED
LENGTH: 20'

C FJP104FL (Fineline)	1 x 4	VG
--------------------------	-------	----

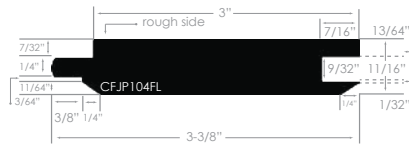

FINGER-JOINTED
LENGTH: 16'

C FJP1344	1 x 4	MG
C FJP1346	1 x 6	MG

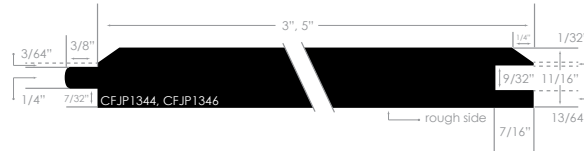



Primed Cedar Pattern Siding

COVE | A/BTR GRADED TO THE SMOOTH FACE

FINGER-JOINTED
LENGTH: 16'

C FJP105 1 x 6 MG
C FJP771 1 x 8 VG

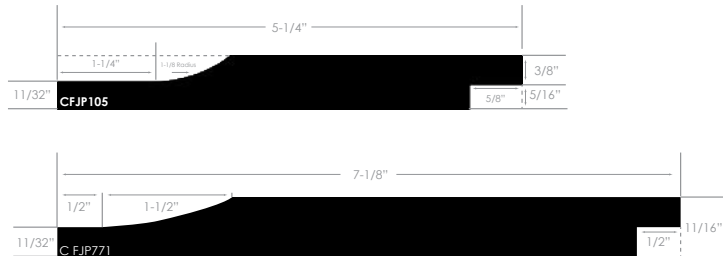

V2E | A/BTR GRADED TO THE SMOOTH FACE

FINGER-JOINTED
LENGTH: 16'

C FJP137 1 x 6 MG
C FJP794 1 x 8 VG

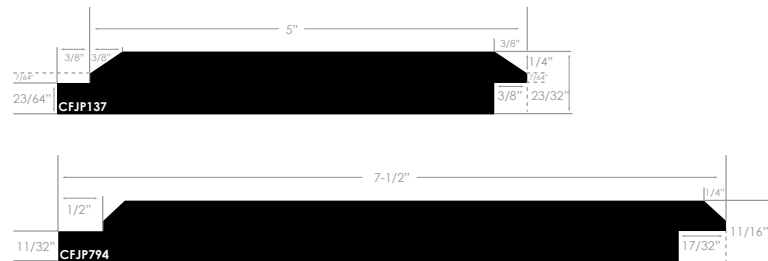

V & CENTER V | A/BTR REVERSIBLE - STRAIGHT SIDE: RESAWN; V SIDE: SMOOTH

FINGER-JOINTED
LENGTH: 16'

C FJP784R 1 x 6 VG
C FJP785R 1 x 8 VG

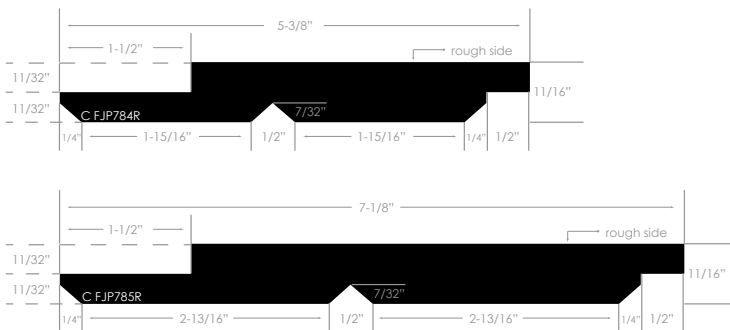

DOUBLE | A/BTR GRADED TO THE SMOOTH FACE

FINGER-JOINTED
LENGTH: 16'

C FJP115 1 x 6 MG
C FJP117 1 x 6 MG

